

Fig. 2
(PRIOR ART)

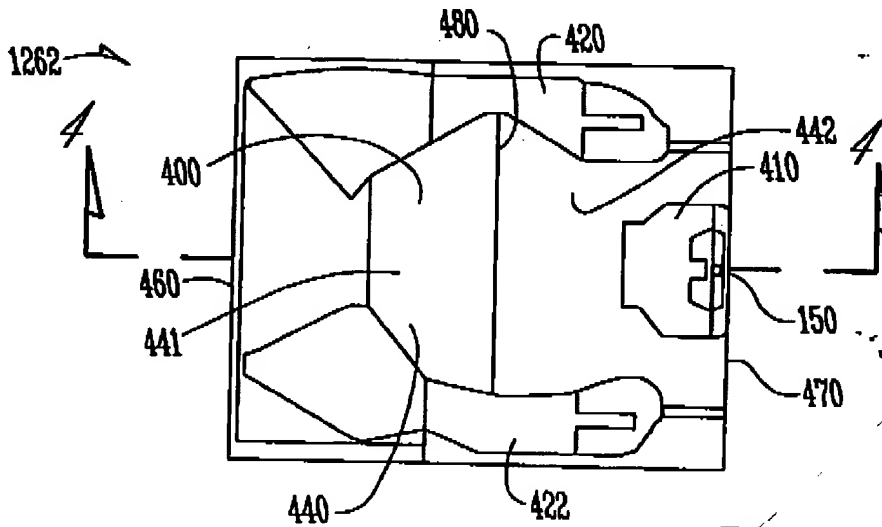

Fig. 3